



Motion Control

In This Section:

- Beam Style
- Bellows Style
- Mini Disc Style
- Oldham Style
- Mini Soft Style
- Curved Jaw Style
- Miniature Jaw Style

MC





Motion Control

MC



Safety Warning

When using Lovejoy products, you must follow these instructions and take the following precautions. Failure to do so may cause the power transmission product to break and parts to be thrown with sufficient force to cause severe injury or death.

Refer to this Lovejoy Catalog for proper selection, sizing, horsepower, torque range, and speed range of power transmission products, including elastomeric elements for couplings. Follow the installation instructions included with the product, and in the individual product catalogs for proper installation of power transmission products. Do not exceed catalog ratings.

During start up and operation of power transmission product, avoid sudden shock loads. Coupling assembly should operate quietly and smoothly. If coupling assembly vibrates or makes beating sound, shut down immediately, and recheck alignment. Shortly after initial operation and periodically thereafter, where applicable, inspect coupling assembly for: alignment, wear of elastomeric element, bolt torques, and flexing elements for signs of fatigue. Do not operate coupling assembly if alignment is improper, or where applicable, if elastomeric element is damaged, or worn to less than 75% of its original thickness.

Do not use any of these power transmission products for elevators, man lifts, or other devices that carry people. If the power transmission product fails, the lift device could fall resulting in severe injury or death.

For all power transmission products, you must install suitable guards in accordance with OSHA and American Society of Mechanical Engineers Standards. Do not start power transmission product before suitable guards are in place. Failure to properly guard these products may result in severe injury or death from personnel contacting moving parts or from parts being thrown from assembly in the event the power transmission product fails.

If you have any questions, contact the Lovejoy Engineering Department at 1-630-852-0500.



Motion Control

MC

Table of Contents

	Running Page No.	Section Page No.
Selection Process.....	96	MC-4
ASB Series > Performance / Dimensional Data.....	98	MC-6
ES and EC Series > Performance / Dimensional Data.....	99	MC-7
ADB Series > Performance / Dimensional Data.....	100	MC-8
BWC Series > Performance / Dimensional Data.....	101	MC-9
BWLC Series > Performance / Dimensional Data.....	102	MC-10
MDSD Series > Performance / Dimensional Data.....	103	MC-11
Quick Reference.....	104	MC-12
MD Series > Performance / Dimensional Data.....	106	MC-14
MDS Series > Performance / Dimensional Data.....	107	MC-15
MOL Series > Performance / Dimensional Data.....	108	MC-16
MSF Series > Performance / Dimensional Data.....	109	MC-17
GS Series > Overview.....	110	MC-18
GS Series > Performance Data.....	111	MC-19
GS Series > Dimensional Data.....	112	MC-20
GS Series > Hub Designs.....	113	MC-21
L Series > Performance / Dimensional Data.....	114	MC-22

Motion Control Coupling Selection Process

- Beam
- Oldham
- Mini-Jaw
- Bellows
- Mini-Soft
- Mini-Disc
- Curved Jaw



The selection process for determining the proper Motion Control coupling starts with selecting the coupling design that best addresses the application requirements. The Lovejoy Motion Control Coupling Quick Reference Chart (pages MC-12 and MC-13) provides a method of weighing performance characteristics of the Beam, Bellows, Mini-Disc, Oldham, Mini-Soft, Curved Jaw, and Mini-Jaw couplings.

MC

Each coupling is compared side by side in critical categories such as: material, torque, torsional stiffness, bore capacity, maximum RPM, misalignment capacity, maximum temperature and moment of inertia. Once a design is selected, the proper size must be determined based on the capabilities of the particular design.

The Beam, Bellows and Mini Disc designs all have a single piece construction, so only one part needs to be selected. The GS Curved Jaw, Oldham, Mini Soft, and Mini Jaw designs have a three piece constructions, consisting of two hubs and an insert. When the shaft size of the driver and driven are the same diameter, the hubs will be the same. When the shaft diameters differ, the hubs selected will differ accordingly.

The following information is necessary before a coupling can be selected:

1. HP and RPM of the driver
2. Shaft size of the driver and driven
3. Application requirements
4. Environmental conditions (i.e. extreme temperature, corrosive conditions, space limitations)
5. Space Limitations (i.e. maximum outside diameter and overall length for the coupling)

<i>Formulas</i>	<i>Chart 1</i>
Nominal Torque =	$\text{in-lbs} = \frac{(\text{HP} \times 63025)}{\text{RPM}}$
	$\text{Nm} = \frac{(\text{KW} \times 9550)}{\text{RPM}}$
Design Torque = Nominal Torque X Application Service Factor	

Steps In Selecting A Motion Control Coupling

Step 1: Determine the nominal torque of your application by using formula in Chart 1.

Step 2: Select a coupling design from the Lovejoy Motion Control Quick Reference Chart (pages MC-12 and MC-13). Proceed to the proper coupling section based on the coupling selected.

Beam Coupling Selection Process

For the Beam coupling, determine if the coupling should be mounted with set screws or by the split/clamp method. The split clamp hub option is recommended for accurate positioning. The Bellows and Mini Disc are available with the clamp style only.

The nominal torque should be treated as the design torque for the Beam coupling design. If the Beam coupling application is non-reversing, the listed torque rating can be used for comparison. If the application is reversing, reduce the nominal torque figure by half. Scan the appropriate column to the first entry where the rated torque value in the column is greater than or equal to the Nominal Torque calculated in Step 1. Over sizing the beam coupling can reduce the amount windup. This can be useful in applications that require close positioning in start/stop/reverse drives.

WARNING

You must refer to page MC-2 (Page 94) for Important Safety Instructions and Precautions for the selection and use of these products. Failure to follow the instructions and precautions can result in severe injury or death.

Bellows Coupling Selection Process

For the BWC and BWLC series Bellows coupling, use the following formulas:

$$\text{Nominal Torque} = \text{in-lbs.} = \text{HP} \times 63025 / \text{RPM}$$

$$\text{Design Torque} = \text{SF} \times \text{Nominal Torque (Motor)} \times \frac{\text{Inertia (Driven)}}{\text{Inertia (Driver)} + \text{Inertia (Driven)}}$$

The Service Factors for the BWC and BWLC series should be: 1.5 for uniform movements, 2.0 for non-uniform movements, and 2.5 (maximum) non-uniform/shock loading movements. The design torque should always be equal to or lower than the nominal rated torque of the coupling. Please consult the allowable misalignment figures on pages MC-9 and MC-10. These figures represent the maximum amount of allowable misalignment.

Mini-Disc Coupling Selection Process

Sizing the Mini-disc coupling, ensure that the maximum torque for the application is under the allowable torque for the particular mini-disc coupling size. Check the maximum bore, misalignment, and torsional stiffness ratings against the requirements of the application.

Oldham, Min-Soft, or Mini-Jaw Coupling Selection Process

When selecting an Oldham style coupling, it should be determined whether a clamp or setscrew style is appropriate. For the Oldham, Mini Soft, or Jaw couplings, refer to the service factor chart below to select the correct service factor for the application. Calculate the design torque by multiplying the nominal torque by the application service factor. Then, select the correct Oldham, Mini Soft, or Jaw size coupling by choosing the size that has a torque rating larger than the calculated design torque.

Oldham, Mini-Soft, and Mini-Jaw Coupling Service Factors

	Constant Torque 0-10 Hrs/Day	Varying Torque 11-24 Hrs/Day	Constant Torque 0-10 Hrs/Day	Varying Torque 11-24 Hrs/Day
Start/Stop = 0-120/Hr Temperature = 50° to 85° F	1.2	1.7	1.7	2.2
Start/Stop=0-120/Hr Temperature = 86° to 104° F	1.4	2.0	2.0	2.6
Start/Stop = 0-120/Hr Temperature = 105° to 140° F	1.7	2.5	2.5	3.2
Start/Stop = 121-240/Hr Temperature = 50° to 85° F	1.5	2.2	2.2	2.8
Start/Stop = 121-240/Hr Temperature = 86° to 104° F	1.8	2.5	2.5	3.3
Start/Stop = 121-240/Hr Temperature = 105° to 140° F	2.2	3.1	3.1	4.1

GS Curved Jaw Coupling Service Factors

Temperature Factor

	-30° to 30° C	40° C	60° C	80° C
K3	1	1,2	1,4	1,8

Torsional Stiffness Factor

	Main Spindle Drive of Machine	Positioning Drive	Shaft Encoders, Angle Encoders
K4	2-5	3-8	10

Shock Load Factors

	K5
Light Shock Loads	1,0
Medium Shock Loads	1,4
Heavy Shock Loads	1,8

GS Curved Jaw Selection Process

$$\text{Rotational inertia coefficient (driver)} = \frac{\text{Moment of inertia (driver)}}{\text{Moment of inertia (driver)} + \text{Moment of inertia (driven)}}$$

$$\text{Rotational inertia coefficient (driven)} = \frac{\text{Moment of inertia (driven)}}{\text{Moment of inertia (driver)} + \text{Moment of inertia (driven)}}$$

Check the nominal torque for the application against the rating for the coupling:

$$T_{kn} > \text{Rated torque of machine} \times K3 \times K4$$

Peak Torque

$$\begin{aligned} \text{Shock load (driver side)} &= \text{Peak torque (driver)} \times \text{rotational inertia coefficient (driver)} \times K5 \\ \text{Shock load (driven side)} &= \text{Peak torque (driven)} \times \text{rotational inertia coefficient (driven)} \times K5 \end{aligned}$$

Check the peak torque for the application against the rating for the coupling (page MC-19), checking both driver and driven sides:

$$T_{kmax} > \text{Peak Torque (driver or driven side)} \times K3 \times K4$$

ASB Series - Aluminum Single Beam Clamp Style Coupling

The ASB (Aluminum Single Beam) Series offers additional outside diameter and overall length dimensions to the EC Series of Beam couplings. These options are extremely helpful in applications where the space available for a coupling is limited. The ASB series also offers slightly larger bore capacities than their equivalent size in the EC Series. The 5 sizes of the ASB Series along with the 3 clamping sizes in the EC Series give designers more options for applications with limited coupling space.



Features

- Zero backlash design
- Anodized aluminum material
- Higher torque than the EC/ES series

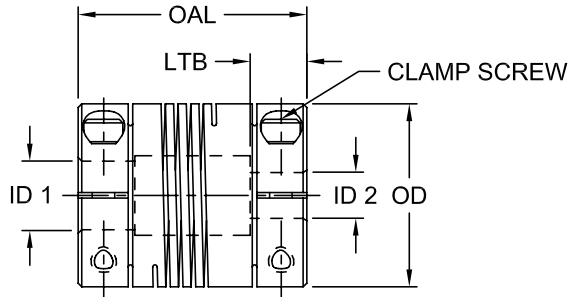

ASB Series Performance Data

Size	Torque Nominal in-lbs*	Torsional Stiffness in-lb/rad*	Max RPM	Weight*		Moment of Inertia* lb-in ²	Misalignment		
				oz	g		Angular °	Parallel in	Axial in
ASB 3	2.0	318.6	10,000	0.2	5.4	0.000	5°	0.005	± 0.010
ASB 3.5	3.4	557.6	10,000	0.3	8.3	0.001	5°	0.005	± 0.010
ASB 4	5.0	442.5	10,000	0.5	15.1	0.002	5°	0.005	± 0.010
ASB 5	10.0	920.4	10,000	1.4	40.6	0.011	5°	0.005	± 0.010
ASB 6	15.0	1,770.0	10,000	3.0	86.2	0.037	5°	0.005	± 0.010

Notes: ■ * indicates: Nominal torque, torsional stiffness, weight and moment of inertia are based on minimum bore size.
 ■ Specify Bore sizes ID1 and ID2 when ordering.

ASB Series Dimensional Data

Size	OAL		LTB		ID1 - ID2				OD		Clamp Screw Size mm
	in	mm	in	mm	Min Bore		Max Bore		in	mm	
					in	mm	in	mm			
ASB 3	0.752	19.1	0.236	6	0.118	3	0.197	5.00	0.500	12.7	M2
ASB 3.5	0.799	20.3	0.236	6	0.157	4	0.250	6.35	0.626	15.9	M2.5
ASB 4	0.902	22.9	0.256	7	0.157	4	0.315	8.00	0.752	19.1	M2.5
ASB 5	1.252	31.8	0.354	9	0.236	6	0.433	11.00	1.000	25.4	M3
ASB 6	1.752	44.5	0.472	12	0.236	6	0.551	14.00	1.252	31.8	M4

ES and EC Series - Single Beam Style Coupling

The Beam flexible coupling is formed from one piece of aluminum rod. A spiral slot is cut through the length of the aluminum tube forming a “spring” center section referred to as a helical coil or beam. The flexure allowed by the beam portion of the coupling is capable of accommodating angular, parallel and axial misalignment while continuing to convey power between the attached shafts. This results in a single piece, true flexible coupling.

The Miniature Beam coupling is designed for very light power transmission applications where accurate positioning of shafts is an essential requirement. It also has a very high tolerance to heat, chemicals, and corrosion that would be harmful to conventional elastomeric flexible couplings. The Miniature Beam coupling design is very well suited for small shaft applications and the inherent requirements of start/stop/reverse applications where zero backlash and extreme positioning accuracy are important. This coupling operates either clockwise or counter clockwise without sacrificing windup or torque capabilities.

Features

- All-metal coupling
- Easy to install – one piece
- High angular misalignment capability to 5°
- Anodized aluminum finish
- Zero backlash design



Set Screw Type (ES)



Clamping Type (EC)

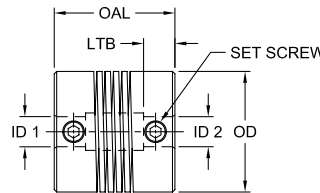

Set Screw Type (ES)

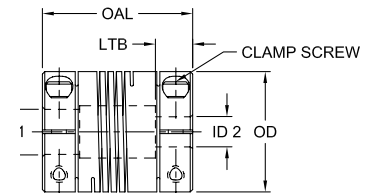

Clamping Type (EC)

MC

ES and EC Series Performance Data

Size	Torque Nominal in-lbs*	Torsional Stiffness in-lb/rad*	Max RPM	Weight*		Moment of Inertia* lb-in ²	Misalignment		
				oz	g		Angular	Parallel in	Axial in
ES 050	1.8	42.8	10,000	0.1	3.6	2.73	5°	0.005	± 0.010
EC 050	1.8	42.8	10,000	0.2	5.8	4.10	5°	0.005	± 0.010
ES 075	5.0	119.4	10,000	0.4	12.0	20.16	5°	0.005	± 0.010
EC 075	5.0	119.4	10,000	0.5	15.0	24.95	5°	0.005	± 0.010
ES 100	11.0	286.5	10,000	1.1	30.0	86.80	5°	0.005	± 0.010
EC 100	11.0	286.5	10,000	1.3	38.0	111.74	5°	0.005	± 0.010
ES 112	17.0	409.3	10,000	1.4	39.0	148.99	5°	0.005	± 0.010
EC 112	17.0	409.3	10,000	1.9	54.0	207.08	5°	0.005	± 0.010

Notes: ■ * indicates: Nominal torque, torsional stiffness, weight and moment of inertia are based on minimum bore size.
 ■ Specify Bore sizes ID1 and ID2 when ordering.

ES and EC Series Dimensional Data

Size	OAL		LTB		ID1 - ID2				OD		Set Screw or Clamp Screw Size	
	in	mm	in	mm	Min Bore		Max Bore		in	mm	in	mm
ES050	0.512	13	0.118	3	0.118	3	0.188	4	0.512	13	4-40	M2.5
EC050	0.748	19	0.197	5	0.118	3	0.188	4	0.512	13	1-72	M1.6
ES075	0.748	19	0.197	5	0.157	4	0.236	6	0.748	19	8-32	M4
EC075	0.906	23	0.236	6	0.157	4	0.236	6	0.748	19	4-40	M2.5
ES100	0.984	25	0.276	7	0.236	6	0.394	10	0.984	25	10-24	M5
EC100	1.260	32	0.315	8	0.236	6	0.394	10	0.984	25	6-32	M3
ES112	1.102	28	0.276	7	0.315	8	0.472	12	1.102	28	1/4-20	M6
EC112	1.496	38	0.433	11	0.315	8	0.472	12	1.102	28	6-32	M3

ADB Series - Aluminum Double Beam Clamp Style Coupling

The ADB (Aluminum Double Beam) Series coupling enhances the beam coupling options available from Lovejoy Inc. The longer overall length allows the ADB series to span longer BSE (between shaft end) measurements. The aluminum material used in its construction keeps the coupling's weight low. The ADB design offers two flex points allowing for greater angular misalignment, up to 7°. This design also allows for up to .024 inches of parallel misalignment. The torque capacity ADB series is more than double the range of the single beam designs, with the largest size having a torque capacity of 88 in-lbs.



Features

- Zero backlash design
- Simple one piece assembly
- Aluminum material
- Largest amount of angular misalignment capacity

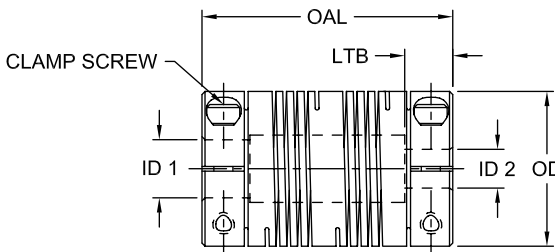

MC

ADB Series Performance Data

Size	Torque Nominal in-lbs*	Torsional Stiffness in-lb/rad*	Max RPM	Weight*		Moment of Inertia* lb-in ²	Misalignment		
				oz	g		Angular	Parallel in	Axial in
ADB 3	3.5	1,097	10,000	0.2	6.5	0.001	5°	0.007	± 0.010
ADB 3.5	6.2	2,584	10,000	0.4	11.5	0.001	7°	0.008	± 0.010
ADB 4	12.0	4,460	10,000	0.6	16.7	0.003	7°	0.010	± 0.010
ADB 5	20.0	6,266	10,000	1.6	44.3	0.013	7°	0.015	± 0.010
ADB 6	38.0	15,266	10,000	3.7	105.8	0.049	7°	0.020	± 0.010
ADB 7	88.0	20,514	10,000	6.2	175.1	0.118	7°	0.024	± 0.010

Notes: ■ * indicates: Nominal torque, torsional stiffness, weight and moment of inertia are based on minimum bore size.
 ■ Specify Bore sizes ID1 and ID2 when ordering.

ADB Series Dimensional Data

Size	OAL		LTB		ID1 - ID2				OD		Set Screw or Clamp Screw Size mm
	in	mm	in	mm	Min Bore		Max Bore		in	mm	
					in	mm	in	mm			
ADB 3	0.902	22.9	0.209	5.3	0.118	3.0	0.250	6.35	0.500	12.7	M2
ADB 3.5	1.000	25.4	0.256	6.5	0.197	5.0	0.315	8.00	0.626	15.9	M2.5
ADB 4	1.043	26.5	0.256	6.5	0.236	6.0	0.394	10.00	0.752	19.1	M2.5
ADB 5	1.500	38.1	0.433	11.0	0.295	7.5	0.500	12.70	1.000	25.4	M3
ADB 6	2.252	57.2	0.630	16.0	0.394	10.0	0.630	16.00	1.252	31.8	M4
ADB 7	2.626	66.7	0.709	18.0	0.394	10.0	0.748	19.00	1.500	38.1	M5

BWC Series - Bellows Clamp Style Coupling

The BWC (Bellows Clamp) Series coupling provides a new range of coupling options with the high torsional stiffness. The higher torsional stiffness provides the benefit of accuracy and repeatability in motion control applications. The BWC series coupling features aluminum hubs and corrosion resistant steel bellow. The compact design also offers the benefit of low inertia. The BWC Series also has a torque capacity of up to 89 in-lbs, with a maximum bore capacity of .748 inches in diameter. The BWC utilizes clamping style hubs that provide easy installation and removal of the coupling. The bellows design also offers up to .016 inches of axial misalignment, with low reactionary loading on bearings.

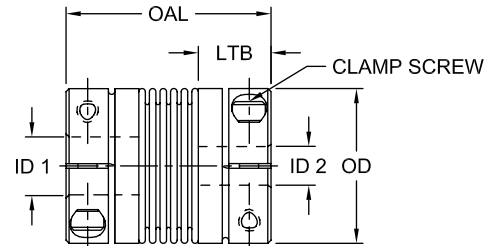

Features

- High torsional stiffness
- Low reactionary loading
- No maintenance required
- Low inertia

BWC Series Performance Data

Size	Torque Nominal in-lbs*	Torsional Stiffness in-lb/rad*	Max RPM	Weight*		Moment of Inertia* lb-in ²	Misalignment		
				oz	g		Angular	Parallel in	Axial in
BWC-21	3.54	2,248	15,000	0.3	9	0.009	1.2°	0.004	0.009
BWC-23	7.97	4,487	15,000	0.3	9	0.009	1.2°	0.004	0.008
BWC-26	13.28	6,620	15,000	0.8	22	0.038	1.2°	0.004	0.010
BWC-32	17.70	13,541	15,000	1.3	36	0.085	1.2°	0.004	0.012
BWC-41	39.83	57,083	15,000	2.6	74	0.335	1.2°	0.004	0.012
BWC-47	88.50	71,420	15,000	4.2	120	0.789	1.2°	0.006	0.016

Notes: ■ * indicates: Nominal torque, torsional stiffness, weight and moment of inertia are based on minimum bore size.
 ■ Specify Bore sizes ID1 and ID2 when ordering.

BWC Series Dimensional Data

Size	OAL		LTB		ID1 - ID2				OD		Clamp Screw Size mm
	in	mm	in	mm	Min Bore		Max Bore		in	mm	
					in	mm	in	mm			
BWC-21	0.827	21	0.276	7.0	0.118	3	0.256	6.5	0.591	15	M2
BWC-23	0.906	23	0.276	7.0	0.118	3	0.256	6.5	0.591	15	M2
BWC-26	1.024	26	0.354	9.0	0.118	3	0.394	10.0	0.748	19	M2.5
BWC-32	1.260	32	0.472	12.0	0.118	3	0.472	12.0	0.945	24	M3
BWC-41	1.614	41	0.551	14.0	0.236	6	0.630	16.0	1.260	32	M4
BWC-47	1.850	47	0.571	14.5	0.315	8	0.748	19.0	1.575	40	M4

BWLC Series - Bellows Clamp Style Coupling

The BWLC (Bellows Clamp) Series coupling specifically addresses higher torque and bore capacities in the area of motion control. The BWLC Series offers the highest amount of torsional stiffness for accuracy and repeatability. The BWLC Series coupling features a corrosion resistant steel bellows and aluminum or steel hubs. The BWLC Series also has a torque capacity of up to 1,328 in-lbs, with a maximum bore capacity of 1.574 inches in diameter. The larger size of the BWLC allows for a greater amount of axial misalignment of .020 inches, with low reactionary loading on bearings.

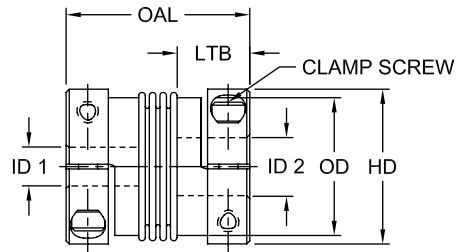

Features

- Highest torsional stiffness
- Low reactionary loading
- No maintenance required
- Low inertia

MC

BWLC Series Performance Data

Size	Torque Nominal in-lbs*	Torsional Stiffness in-lb/rad*	Max RPM	Weight*		Moment of Inertia* lb-in ²	Misalignment		
				oz	g		Angular	Parallel in	Axial in
BWLC-63	159	70,800	12,700	7.05	200	0.273	1.5°	0.008	0.020
BWLC-65	266	318,600	10,200	10.58	300	0.547	1.0°	0.004	0.016
BWLC-78	531	646,050	8,600	21.16	600	1.709	1.0°	0.004	0.016
BWLC-91	1,328	1,336,350	6,800	81.13	2,300	9.561	1.0°	0.008	0.016

Notes: ■ * indicates: Nominal torque, torsional stiffness, weight and moment of inertia are based on minimum bore size.
 ■ Specify Bore sizes ID1 and ID2 when ordering.

BWLC Series Dimensional Data

Size	OAL		LTB		ID1 - ID2				HD**		OD		Clamp Screw Size mm
	in	mm	in	mm	Min Bore		Max Bore		in	mm	in	mm	
BWLC-63	2.480	63	0.472	12.0	0.394	10	0.984	25	1.772	45	1.772	45	M5
BWLC-65	2.559	65	0.591	15.0	0.394	10	0.984	25	1.850 / 2.205	47 / 56	2.205	56	M6
BWLC-78	3.071	78	0.768	19.5	0.551	14	1.378	35	2.244 / 2.598	57 / 66	2.598	66	M8
BWLC-91	3.583	91	0.846	21.5	0.787	20	1.575	40	2.677 / 3.150	68 / 80	3.228	82	M10
									3.307	84			

Note: ■ ** indicates: Various hub diameters available to accommodate different size bore diameters.

MDSD Series - Mini Disc Single Disc Clamp Style Coupling

The compact design of the MDSD (Mini Disc Single Disc) Series accommodates applications that allow for a minimum amount of space for the coupling. The MDSD Series coupling also features a high torsional stiffness over the MD and MDS Series. The MDSD Series also has the lowest inertia of the mini disc designs.

Features

- Zero backlash design
- Highest torsional stiffness
- Aluminum hubs with stainless steel discs
- Moderate-high torque capabilities
- Low Inertia

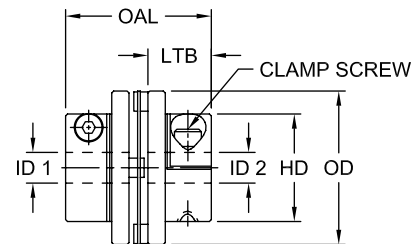

MC





MDSD Series Performance Data

Size	Torque Nominal in-lbs*	Torsional Stiffness in-lb/rad*	Max RPM	Weight*		Moment of Inertia* lb-in ²	Misalignment		
				oz	g		Angular	Parallel in	Axial in
MDSD-32C	18	11,505	4,800	1.34	38	0.015377	1°	N/A	± 0.20
MDSD-40C	35	24,780	3,800	2.33	66	0.041006	1°	N/A	± 0.20
MDSD-50C	66	32,745	3,100	4.23	120	0.126435	1°	N/A	± 0.20
MDSD-63C	89	44,250	2,400	6.70	190	0.287042	1°	N/A	± 0.20

Notes: ■ * indicates: Nominal torque, torsional stiffness, weight and moment of inertia are based on minimum bore size.
 ■ N/A indicates: Not Applicable.
 ■ Specify Bore sizes ID1 and ID2 when ordering.

MDSD Series Dimensional Data

Size	OAL		LTB		ID1 - ID2				OD		HD		Clamp Screw Size mm
	in	mm	in	mm	Min Bore		Max Bore		in	mm	in	mm	
					in	mm	in	mm					
MDSD-32C	1.260	32	0.539	13.7	0.118	4	0.394	10	1.260	32	0.866	22	M3
MDSD-40C	1.496	38	0.650	16.5	0.236	6	0.551	14	1.575	40	1.102	28	M4
MDSD-50C	1.732	44	0.764	19.4	0.394	10	0.787	20	1.969	50	1.535	39	M5
MDSD-63C	1.969	50	0.878	22.3	0.472	12	0.984	25	2.480	63	1.772	45	M6

Coupling Types	Beam			Bellows	
					
Summary of Design	ES/EC Series	ASB Series	ADB Series	BWC Series	BWLC Series
	Single beam with setscrew or clamping options	Single beam with clamping style for higher torque applications	Double Beam clamping style coupling	Standard Bellows style coupling	Bellows style coupling
Material Type	Anodized Aluminum	Anodized Aluminum	Aluminum	Aluminum hubs with stainless steel bellows	Aluminum hubs with stainless steel bellows
Torque Capacity (Nominal)	up to 17 in-lbs	up to 15 in-lbs	up to 88 in-lbs	up to 88.5 in-lbs	up to 1,328 in-lbs
Torsional Stiffness	up to 409 in-lb/rad	up to 1,770 in-lb/rad	up to 20,514 in-lb/rad	up to 71,420 in-lb/rad	up to 1,33,350 in-lb/rad
Bore Capacity	up to .500 inches	up to .551 inches	up to .866 inches	up to .748 inches	up to 1.574 inches
Maximum RPM	up to 10,000 RPM	up to 10,000 RPM	up to 10,000 RPM	up to 15,000 RPM	up to 12,700 RPM
Angular Misalignment	up to 5°	up to 5°	up to 7°	up to 1.2°	up to 1.5°
Parallel Misalignment	.005 inches	.005 inches	.024 inches	.006 inches	.008 inches
Axial Misalignment	+/- .010 inches	+/- .010 inches	+/- .010 inches	up to +/- .016 inches	up to +/- .020 inches
Maximum Temperature	200° F	200° F	200° F	212° F	212° F
Moment of Inertia	Up to 207 [lb-in ²]	Up to 0.037 [lb-in ²]	Up to 118 [lb-in ²]	Up to .78937 [lb-in ²]	Up to 9.561 [lb-in ²]

Mini-Disc			Oldham	Mini Soft	GS Curved Jaw	Mini Jaw
						
MD Series	MDS Series	MDS Series	MOL Series	MSF Series	GS Series	L Series
Standard mini disc configuration utilizing two disc packs	Spacer version of the minidisc style coupling	Single disc pack version of the mini disc coupling	Three piece coupling design with Polyacetel insert	Three piece design with Polyurethane sleeve insert	Three piece jaw coupling design with Urethane or Hytrel® insert	Three piece jaw design with buna-N Urethane, or Hytrel® Spider
Aluminum Hubs with stainless steel disc	Aluminum Hubs with stainless steel disc	Aluminum Hubs with stainless steel disc	Aluminum Hhubs, Polyacetel insert	Zinc Alloy/ sintered iron hubs, polyurethane	Aluminum or steel hubs, urethane or Hytrel® insert	Sintered iron hubs, Buna-N, Urethane, or Hytrel® Spider
up to 111 in-lbs	up to 221 in-lbs	up to 89 in-lbs	up to 40 in-lbs	up to 27 in-lbs	up to 7301 in-lbs	up to 50 in-lbs
up to 26,550 in-lb/rad	up to 22,125 in-lb/rad	up to 44,250 in-lb/rad	up to 7,877 in-lb/rad	up to 266 in-lb/rad	up to 366,921 in-lb/rad	N/A
up to 1.18 inches	up to 1,000 inches	up to 1,000 inches	up to .500 inches	up to .500 inches	up to 2.75 inches	up to .625 inches
up to 10,000 RPM	up to 4,800 RPM	up to 4,800 RPM	up to 24,000 RPM	up to 24,000 RPM	up to 25,400 RPM	up to 31,000 RPM
up to 1.5°	up to 2°	up to 1°	up to 3°	up to 2°	up to 1.3°	up to 1°
.006 inches	.010 inches	N/A	.100 inches	.010 inches	.027 inches	.015 inches
+/- .020 inches	+/- .031 inches	+/- .008 inches	+/- .008 inches	N/A	N/A	N/A
300° F	300° F	300° F	176° F	140° F	up to 248° F	up to 250° F
Up to .72 [lb-in ²]	Up to .376 [lb-in ²]	Up to .287 [lb-in ²]	Up to .304 [lb-in ²]	Up to .092 [lb-in ²]	Up to .135 [lb-in ²]	Up to .070 [lb-in ²]

MC

MD Series - Mini Disc Clamp Style Coupling

The MD (mini disc) Series coupling features a higher torque capacity over elastomeric coupling types. The MD Series one piece clamping design allows for easy removal and assembly. The Aluminum hubs and stainless steel disc materials allow for excellent resistance to oil and other chemicals. The MD Series design offers moderate torsional stiffness for applications requiring repeatability. The MD Series also offers up to .020 inches of axial misalignment.

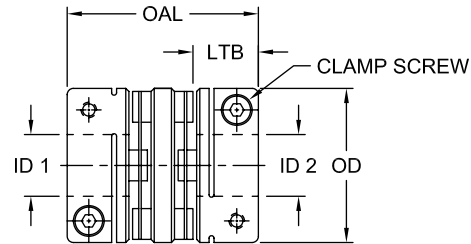

Features

- Zero backlash design
- Moderate torsional stiffness
- Aluminum hubs with stainless steel discs
- Moderate-high torque capabilities

MC

MD Series Performance Data

Size	Torque Nominal in-lbs*	Torsional Stiffness in-lb/rad*	Max RPM	Weight*		Moment of Inertia* lb-in ²	Misalignment		
				oz	g		Angular	Parallel	Axial
MD-19C	6	1,770	10,000	0.635	18	0.003	1.5°	0.005	± 0.20
MD-25C	9	3,983	8,000	0.882	25	0.009	1.5°	0.005	± 0.20
MD-32C	22	9,735	6,000	2.116	60	0.033	1.5°	0.006	± 0.20
MD-40C	31	12,390	5,000	3.527	100	0.065	1.5°	0.006	± 0.20
MD-50C	80	19,470	4,000	7.408	210	0.028	1.5°	0.006	± 0.20
MD-63C	111	26,550	3,000	11.993	340	0.718	1.5°	0.006	± 0.20

Notes: ■ * indicates: Nominal torque, torsional stiffness, weight and moment of inertia are based on minimum bore size.
 ■ Specify Bore sizes ID1 and ID2 when ordering.

MD Series Dimensional Data

Size	OAL		LTB		ID1 - ID2				OD		Clamp Screw Size mm
	in	mm	in	mm	Min Bore		Max Bore		in	mm	
					in	mm	in	mm			
MD-19C	1.063	27	0.315	8	0.157	4	0.315	8	0.748	19	M2
MD-25C	1.220	31	0.394	10	0.236	6	0.472	12	0.984	25	M2.5
MD-32C	1.575	40	0.472	12	0.315	8	0.591	15	1.260	32	M3
MD-40C	1.732	44	0.551	14	0.315	8	0.787	20	1.575	40	M4
MD-50C	2.244	57	0.709	18	0.551	14	0.984	25	1.969	50	M5
MD-63C	2.402	61	0.787	20	0.591	15	1.181	30	2.480	63	M6

MDS Series – Mini Disc Spacer Clamp Style Coupling

The MDS (mini disc spacer) Series coupling features a higher parallel misalignment capacity over standard MD Series at .006 inches. The MDS Series also has the highest parallel misalignment at .012 inches and angular misalignment at 2° of any of the mini disc couplings.

Features

- Zero backlash design
- High torsional stiffness
- Aluminum hubs with stainless steel discs
- Moderate-high torque capabilities
- Low Inertia

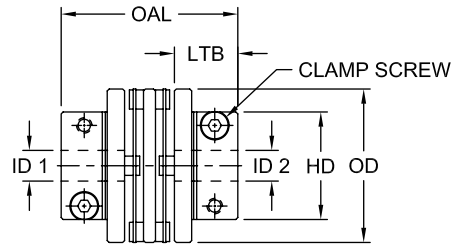

MC

MDS Series Performance Data

Size	Torque Nominal in-lbs*	Torsional Stiffness in-lb/rad*	Max RPM	Weight*		Moment of Inertia* lb-in ²	Misalignment		
				oz	g		Angular	Parallel in	Axial in
MDS-32C	18	8,850	4,800	1.69	48	0.212	2°	0.006	± 0.016
MDS-40C	35	13,275	3,800	2.86	81	0.055	2°	0.007	± 0.016
MDS-50C	66	17,700	3,100	5.29	150	0.157	2°	0.007	± 0.024
MDS-63C	89	22,125	2,400	8.11	230	0.376	2°	0.012	± 0.031

Notes: ■ * indicates: Nominal torque, torsional stiffness, weight and moment of inertia are based on minimum bore size.
 ■ Specify Bore sizes ID1 and ID2 when ordering.

MDS Series Dimensional Data

Size	OAL		LTB		ID1 - ID2				OD		HD		Clamp Screw Size mm
	in	mm	in	mm	Min Bore		Max Bore		in	mm	in	mm	
					in	mm	in	mm					
MDS-32C	1.575	40	0.539	13.7	0.236	6	0.394	10	1.260	32	0.866	22	M3
MDS-40C	1.811	46	0.650	16.5	0.315	8	0.551	14	1.575	40	1.102	28	M4
MDS-50C	2.047	52	0.764	19.4	0.472	12	0.787	20	1.969	50	1.535	39	M5
MDS-63C	2.283	58	0.878	22.3	0.591	15	0.984	25	2.480	63	1.772	45	M6

MOL Series - Oldham Style Coupling

The Lovejoy Oldham coupling is a precision engineered, torsionally stiff, three-piece coupling suitable for a great many applications ranging from incremental control of fluid valves to highly dynamic drives in closed loop servo systems. It accommodates misalignment mechanically through a floating disc that engages tenons machined out of the hubs. As the coupling rotates, the floating disc aligns with each hub alternately to an extent demanded by the alignment error.



Because parallel misalignment is accommodated by lateral displacement, the Lovejoy Oldham coupling can handle severe alignment errors within a short space envelope. This is a valuable feature in densely packaged and blind assemblies, or where misalignment can accelerate the erosion of shaft bearings.

The Lovejoy Oldham coupling features raised dots on both sides of the floating disc which act as an effective spacer. The dots keep the face of the tenon from contacting the bottom of the floating disc and allows the coupling greater angular misalignment capability. A very important effect is that the spacer dots will greatly reduce the bending load on the shafts because of the freedom of the floating disc.

MC The MOL Coupling consists of two hubs and one center member.

Features

- High torsional stiffness
- Maximum temperature 176° F (80° C)
- Aluminum hubs with a Polyacetal insert
- Available in setscrew or clamping style hubs

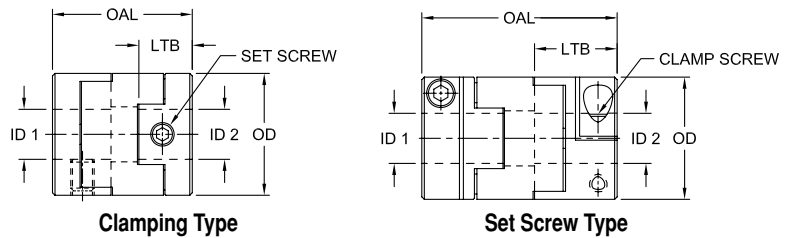

MOL Series Performance Data

Size	Torque Nominal in-lbs*	Torsional Stiffness in-lb/rad*	Max RPM	Weight*		Moment of Inertia* lb-in ²	Misalignment		
				oz	g		Angular	Parallel in	Axial in
MOL-16	6.2	620	24,000	0.2	7	0.001	3°	0.40	N/A
MOL-16C	6.2	620	9,500	0.4	11	0.001	3°	0.40	N/A
MOL-20	10.6	974	19,000	0.5	15	0.003	3°	0.60	N/A
MOL-20C	10.6	974	7,600	0.8	22	0.004	3°	0.60	N/A
MOL-25	17.7	1,770	15,000	1.0	28	0.008	3°	0.80	N/A
MOL-25C	17.7	1,770	6,100	1.4	40	0.011	3°	0.80	N/A
MOL-32	39.8	7,877	12,000	1.9	55	0.025	3°	0.10	N/A
MOL-32C	39.8	7,877	4,800	2.6	75	0.034	3°	0.10	N/A

Notes: ■ * indicates: Nominal torque, torsional stiffness, weight and moment of inertia are based on minimum bore size.
 ■ N/A indicates: Not Applicable.
 ■ Specify Bore sizes ID1 and ID2 when ordering.

MOL Series Dimensional Data

Size	Attachment	OAL		LTB		ID1 - ID2				OD		Set Screw/ Clamp Screw Size mm
		in	mm	in	mm	Min Bore		Max Bore		in	mm	
						in	mm	in	mm			
MOL-16	Set Screw	0.709	18	0.276	7.0	0.118	3	0.236	6	0.630	16	M3
MOL-16C	Clamp	1.142	29	0.492	12.5	0.118	3	0.236	6	0.630	16	M2.6
MOL-20	Set Screw	0.906	23	0.354	9.0	0.118	3	0.315	8	0.787	20	M4
MOL-20C	Clamp	1.299	33	0.551	14.0	0.118	3	0.315	8	0.787	20	M2.6
MOL-25	Set Screw	1.102	28	0.433	11.0	0.197	5	0.394	10	0.984	25	M5
MOL-25C	Clamp	1.535	39	0.650	16.5	0.197	5	0.394	10	0.984	25	M3
MOL-32	Set Screw	1.299	33	0.512	13.0	0.315	8	0.551	14	1.260	32	M6
MOL-32C	Clamp	1.772	45	0.748	19.0	0.315	8	0.551	14	1.260	32	M4

MSF Series - Mini Soft Style Coupling

The Lovejoy Mini Soft coupling provides protection from misalignment, vibration and shock loads. The simple design of the coupling ensures ease of assembly, installation and reliable performance. No special tools are needed for installation or removal. No lubrication is needed, and once installed and aligned correctly, no maintenance is required.

The Mini Soft coupling design is comprised of three parts. Two hubs with internal teeth engage an elastomeric flexible center, or sleeve, with external teeth. Misalignment and torsional shock loads are absorbed by shear deflection in the center sleeve element.

The shear characteristic of the coupling is very well suited to absorb impact. The Lovejoy Mini Soft coupling is designed with tooth contact which provides more surfaces carrying the load resulting in less wear at any one point, and torque that flows more smoothly. Additionally, the coupling allows for axial freedom which results in easier assembly and spacing of shafts. This feature is particularly useful in reducing thrust loads on bearings.

When operating within its rating, the coupling is torsionally stiff and will not react with twist during operation. The Polyurethane center member sleeve is known for its toughness and resistance to abrasion, and also provides for good damping and shock load capabilities.

The MSF coupling consists of two hubs and one center member.

Features

- Easy blind assembly
- Good shock load absorption
- Good abrasion resistance
- Zinc alloy hubs
- Polyurethane insert

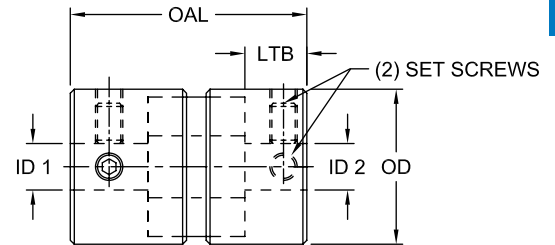

MC

MSF Series Performance Data

Size	Torque Nominal in-lbs*	Torsional Stiffness in-lb/rad*	Max RPM	Weight*		Moment of Inertia* lb-in2	Misalignment		
				oz	g		Angular	Parallel in	Axial in
MSF-16	4.4	27	24,000	0.8	22	0.003	2°	0.01	N/A
MSF-20	8.9	80	19,000	1.5	43	0.010	2°	0.01	N/A
MSF-25	13.3	106	15,000	3.0	84	0.028	2°	0.01	N/A
MSF-32	26.6	266	12,000	5.6	160	0.092	2°	0.01	N/A

Notes: ■ * indicates: Nominal torque, torsional stiffness, weight and moment of inertia are based on minimum bore size.

■ N/A indicates: Not Applicable.

■ Specify Bore sizes ID1 and ID2 when ordering.

MSF Series Dimensional Data

Size	OAL		LTB		ID1 - ID2				OD		Set Screw Size mm
	in	mm	in	mm	Min Bore		Max Bore		in	mm	
					in	mm	in	mm			
MSF-16	1.063	27	0.315	8	0.118	3	0.315	8	0.630	16	M3
MSF-20	1.339	34	0.394	10	0.197	5	0.394	10	0.787	20	M3
MSF-25	1.614	41	0.472	12	0.197	5	0.472	12	0.984	25	M4
MSF-32	1.890	48	0.551	14	0.315	8	0.551	14	1.260	32	M4

GS Series - Curved Jaw Style Coupling

The GS Series curved jaw coupling offers zero backlash capability in a 3-piece design. The coupling is provided assembled under prestress. The GS Series can be used in a variety of different applications requiring precision and accuracy.

The GS Series spider features a straight center of the spider tooth, providing higher stiffness due to coupling prestress. The crowning of the ends of the spider legs allows for misalignment, while the curved jaws and solid spider center provide high-speed capability.

The jaws of the hubs and the spider legs are chamfered to provide easy assembly. The GS Series coupling design also allows the blind assembly in tight spaces. Raised spider dots on the legs of the spider ensure proper spacing of hubs and spider.

The GS Series coupling has spiders available in four different shore hardnesses. Each spider offers benefits for different vibratory, environmental, and torque transmission requirements.

The GS Curved Jaw coupling consists of two hubs and one spider.



MC

Features

- Simple 3 piece jaw design
- Aluminum and steel material hubs
- Clamping and locking device hubs available
- Four different types of urethane shores to chose from

Typical Applications

Measurement And Control Systems

The torsional stiffness of the GS Series coupling provides zero backlash needed for the accuracy for measurement and control systems. The low torques of these applications gives the GS Series the ability to provide zero backlash due to the elastomer pre-stress.

Servo And Positioning Drives

The GS Series provides a zero backlash, flexible connection for servo and positioning drives. An added benefit of the GS Series is its damping capabilities. For applications that have vibrations at critical speeds, the GS Series coupling can provide a zero backlash solution for vibration problems.

Main Spindle Drives

The GS Series coupling is used in main spindle drives for machine tools. Torque spikes and cyclical loading are handled by the GS Series by damping or by shifting the vibratory frequency range to a non-critical speed range.

Elastomer Performance Data

Spider Type	Color	Metal	Temperature Range		Sizes Available	Typical Applications
			Normal	Maximum		
80 Shore A GS	Blue	Urethane	-50° to 176° F	-80° to 248° F	14 - 24	Electric measuring systems
92 Shore A GS	Yellow	Urethane	-40° to 194° F	-50° to 248° F	14 - 55	Electric measuring systems and control systems
95/98 Shore A GS	Red	Urethane	-30° to 194° F	-40° to 248° F	14 - 55	Positioning drives, main spindle drives, high load applications
64 Shore D GS	Green	Urethane	-20° to 230° F	-30° to 248° F	14 - 55	High load applications torsionally stiff spider material

GS Series Performance Data

Size	Spider Durometer	Maximum Speed for Clamping Styles			Torque		Static Torsional Stiffness	Dynamic Torsional Stiffness	Radial Stiffness	Complete Coupling		MC			
		Clamping Hub	Set Screw Hub	Locking Device Hub	Tkn	Tkmax				Max Bore w/o Keyway					
										RPM	RPM		RPM	Weight	Polar Moment of Inertia J
											lb	(lb-in ²) (x10 ⁻⁶)			
14	80 Sh A	12,700	15,900	25,400	35.4	70.8	532.8	1,593	874	0.098	57				
	92 Sh A				66.4	132.8							1,014.0	3,044	1,920
	98 Sh A				110.6	221.3							1,521.0	4,540	3,452
	64 Sh D				141.6	283.2							2,072.0	6,212	4,892
19/24	80 Sh A	9,550	11,900	19,000	43.4	86.7	3,042.0	9,115	3,326	0.306	374				
	92 Sh A				88.5	177.0							5,071.0	15,222	6,401
	98 Sh A				150.5	300.9							7,606.0	22,833	11,487
	64 Sh D				185.9	371.7							10,976.0	32,922	16,745
24/32	92 Sh A	6,950	8,850	13,800	309.8	619.5	12,673.0	38,019	8,458	0.621	965				
	98 Sh A				531.0	1,062.0							18,257.0	54,772	14,630
	64 Sh D				663.8	1,327.0							26,355.0	79,065	21,123
28/38	92 Sh A	5,850	7,350	11,700	840.8	1,681.0	20,284.0	60,852	10,173	1.178	3,691				
	98 Sh A				1,415.0	2,832.0							30,426.0	91,278	18,288
	64 Sh D				1,770.0	3,540.0							38,497.0	115,492	24,849
38/45	92 Sh A	4,750	5,950	9,550	1,681.0	3,363.0	40,586.0	121,705	12,430	2.112	7,485				
	98 Sh A				2,876.0	5,752.0							63,366.0	190,151	25,146
	64 Sh D				3,584.0	7,168.0							93,279.0	279,837	36,999
42/55	92 Sh A	4,000	5,000	8,050	2,345.0	4,690.0	55,755.0	128,236	13,887	8.324	40,639				
	98 Sh A				3,982.0	7,965.0							169,920.0	424,800	31,833
	64 Sh D				4,956.0	9,912.0							244,083.0	610,207	41,548
48/60	92 Sh A	3,600	4,550	7,200	2,743.0	5,487.0	69,472.0	159,786	14,745	11.317	68,782				
	98 Sh A				4,646.0	9,292.0							197,974.0	494,936	33,890
	64 Sh D				5,796.0	11,593.0							320,370.0	800,925	47,286
55/70	92 Sh A	3,150	3,950	6,350	3,628.0	7,257.0	84,075.0	193,372	17,031	16.993	135,334				
	98 Sh A				6,062.0	12,124.0							210,630.0	526,575	38,210
	64 Sh D				7,301.0	14,602.0							366,921.0	917,302	52,852

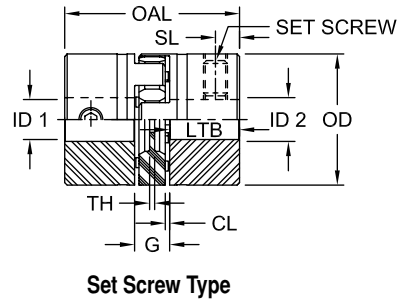
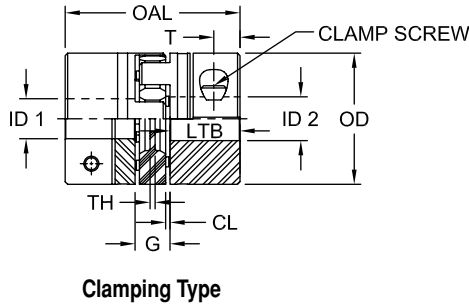

GS Series Dimensional Data

Size	Material	OAL		LTB		ID1 - ID2				OD		Set Screw / Clamp Screw Size mm
		in	mm	in	mm	Min Bore		Max Bore		in	mm	
						in	mm	in	mm			
14	Aluminum	1.378	35	0.433	11	0.197	5	0.551	14	1.181	30	M3
19/24	Aluminum	2.598	66	0.984	25	0.315	8	0.945	24	1.575	40	M2.6
24/32	Aluminum	3.071	78	1.181	30	0.472	12	1.260	32	2.165	55	M4
28/38	Aluminum	3.543	90	1.378	35	0.709	18	1.496	38	2.559	65	M2.6
38/45	Aluminum	4.488	114	1.772	45	0.709	18	1.772	45	3.150	80	M5
42/55	Steel	4.961	126	1.969	50	0.709	18	2.165	55	3.740	95	M3
48/60	Steel	5.512	140	2.205	56	0.709	18	2.362	60	4.134	105	M6
55/70	Steel	6.299	160	2.559	65	1.024	26	2.756	70	4.724	120	M4

Notes: ■ Specify keyway size if needed when ordering.
 ■ Specify bore sizes ID1 and ID2 when ordering.

GS Series Dimensional Data

Continued

Size	Material	T	Clamp Screw Size		SL	Set Screw Size		TH		CL		G	
		in	mm	mm	in	in	in	mm	in	mm	in	mm	
14	Aluminum	0.20	M3	mm	0.20	8-32	in	0.079	2.0	0.039	1.0	0.512	13
19/24	Aluminum	0.47	M2.6	mm	0.39	10-24	in	0.118	3.0	0.079	2.0	0.630	16
24/32	Aluminum	0.55	M4	mm	0.39	10-24	in	0.118	3.0	0.079	2.0	0.709	18
28/38	Aluminum	0.59	M2.6	mm	0.59	5/16-18	in	0.157	4.0	0.098	2.5	0.787	20
38/45	Aluminum	0.79	M5	mm	0.59	5/16-8	in	0.157	4.0	0.118	3.0	0.945	24
42/55	Steel	0.79	M3	mm	0.79	5/16-8	in	0.157	4.0	0.118	3.0	1.024	26
48/60	Steel	0.87	M6	mm	0.79	5/16-8	in	0.157	4.0	0.138	3.5	1.102	28
55/70	Steel	0.98	M4	mm	0.79	3/8-16	in	0.177	4.5	0.157	4.0	1.181	30

GS Series Hub Design Descriptions

The GS Series coupling features different hub designs for different application situations. Each type offers specific benefits for different types of applications. The clamping styles offer the benefit of minimal to zero backlash.

Clamping Hub With Single Slot Without Keyway (C)

Zero backlash, clamping style for torque transmission. Torque capacity of hub depends on bore size. Available standard for sizes GS 14-19.

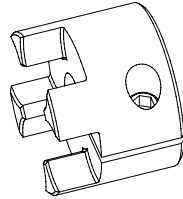

Clamping Hub With Single Slot With Keyway (CWK)

Zero backlash, clamping style with keyway for torque transmission. Usable in applications featuring reversing loads. Available standard for sizes GS 14-19.

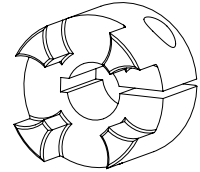

Clamping Hub With Double Slot Without Keyway (DSC)

Transmits torque utilizing a double split clamp to attach hub to shaft. Zero or minimum backlash. Torque capacity of coupling determined by bore size. Available standard for sizes GS 24-55.

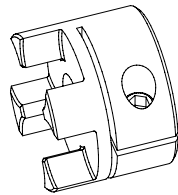

Clamping Hub With Double Slot With Keyway (DSCK)

Transmits torque utilizing a double split clamp to attach hub to shaft. Zero or minimum backlash. Available standard for sizes GS 24-55.

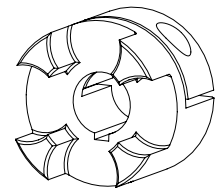

Hub With Frictional Locking (LD)

This hub utilizes a shaft locking device to allow for shaft engagement. This design features bolts tightened on the jaw side of the hub. Available for sizes GS 14-55.

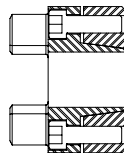

L Series - Miniature Jaw Style Coupling

The Lovejoy Miniature Jaw coupling provides positive engagement resulting in great strength because of the large area of contact of the elastomer or “spider” center member with the interlocking jaws. This Miniature coupling provides “fail safe” operations and is the only coupling that will continue to run, even if the elastomer “spider” fails. Torque will continue to be transmitted through the metal jaw contact.

Good torsional stiffness is provided due to high compression loading. Vibration control is provided through the elastomer center member “spider” and its excellent damping ability. Raised “dots”, a Lovejoy feature, designed into the elastomer center member “spider”, separate the jaw of one hub from the face of the other hub, and automatically set the spacing between the hubs.

The Jaw type coupling design provides rubber in compression which accommodates much more load without failure than rubber in shear or tension.

The Miniature Jaw coupling is radially stiff when misaligned beyond its limits of .015 offset and 1° angular. Radial stiffness results in radial loads on the bearings, called reactionary loads. As the elastomer “set” takes place, the radial loads are eased.

The L-line Miniature Jaw coupling consists of two hubs and one spider.

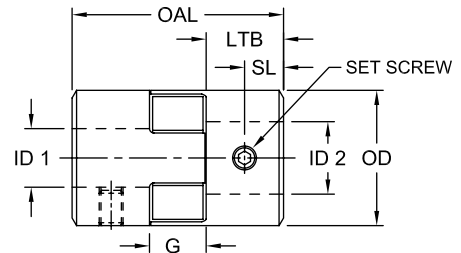

Elastomer Materials

NBR (SOX) Rubber – Nitrile Butadiene Rubber NBR (SOX) is a flexible insert material that is oil resistant, resembles natural rubber in resilience and elasticity and operates effectively in a temperature range of -40° to 212° F (-40° to 100° C). NBR (SOX) also provides good resistance to oil and is the standard Jaw coupling elastomer.

Urethane – Urethane has greater torque capability (1.5 times) than NBR (SOX), provides less damping effect, and operates at a temperature range of - 30° to 160° F (-34° to 71° C) and has good resistance to oil and chemicals.

Hytrel® – Hytrel is a flexible elastomer designed for high torque and high temperature operations. Hytrel can operate in temperatures of -60° to 250° F (- 51° to 121° C) and has an excellent resistance to oil and chemicals.

Bronze – Bronze is a rigid, porous, oil-impregnated metal insert exclusively for slow speed (maximum 250 RPM) applications requiring high torque capabilities. Bronze operations are not affected by extreme temperatures, water, oil or dirt.

Hub Material:	Sintered iron	
Center Material:	NBR (SOX) Rubber	L035 & L050
	Urethane	L050 only
	Hytrel®	L050 only
	Bronze	L050 only

Features

- Positive engagement with jaw interlocking
- Fail safe
- Good torsional stiffness
- Vibration damping ability
- Easy to install
- Center elastomer dits keep hubs form touching
- Exceptional overload capacity
- Spider arms are in compression
- Widely distributed
- Choice in center elastomer hardness

L Series Dimensional Data

Size	Torque Nominal Sox in-lbs	OAL		LTB		SL		ID1 - ID2			
		in	mm	in	mm	in	mm	Min Bore		Max Bore	
								in	mm	in	mm
L-035	3.5	0.752	19.1	0.276	7	33	3	0.118	3	0.394	10
L-050	26.3	1.34	20.3	0.472	12	128	8	0.236	6	0.630*	16

L Series Dimensional Data

Continued

Size	G		OD		Approximate Weight (lbs)		Moment of Inertia lb-in ² (solid)	Set Screw Size mm
	in	mm	in	mm	Solid lbs	Max Bore lbs		
L-035	0.276	7	0.630	16	0.1	0.083	0.003	M2
L-050	0.630	16	1.063	27	0.3	0.240	0.054	M2.5

- Notes:
- * indicates: Maximum bore without keyway.
 - Specify keyway size if needed when ordering.
 - Specify bore sizes ID1 and ID2 when ordering.